

# LME49721

*LME49721 High Performance, High Fidelity Rail-to-Rail Input/Output Audio  
Operational Amplifier*



Literature Number: SNAS371B

# LME49721

## High Performance, High Fidelity Rail-to-Rail Input/Output Audio Operational Amplifier

### General Description

The LME49721 is a low distortion, low noise Rail-to-Rail Input/Output operational amplifier optimized and fully specified for high performance, high fidelity applications. Combining advanced leading-edge process technology with state-of-the-art circuit design, the LME49721 Rail-to-Rail Input/Output operational amplifier delivers superior signal amplification for outstanding performance. The LME49721 combines a very high slew rate with low THD+N to easily satisfy demanding applications. To ensure that the most challenging loads are driven without compromise, the LME49721 has a high slew rate of  $\pm 8.5V/\mu s$  and an output current capability of  $\pm 9.7mA$ . Further, dynamic range is maximized by an output stage that drives  $10k\Omega$  loads to within 10mV of either power supply voltage.

The LME49721 has a wide supply range of 2.2V to 5.5V. Over this supply range the LME49721's input circuitry maintains excellent common-mode and power supply rejection, as well as maintaining its low input bias current. The LME49721 is unity gain stable.

### Key Specifications

- Power Supply Voltage Range                      2.2V to 5.5V
- Quiescent Current                                      2.15mA (typ)
- THD+N  
( $A_V = 2, V_{OUT} = 4V_{p-p}, f_{IN} = 1kHz$ )
  - $R_L = 2k\Omega$     0.00008% (typ)
  - $R_L = 600\Omega$     0.0001% (typ)
- Input Noise Density                                   $4nV/\sqrt{Hz}$  (typ), @ 1kHz

- Slew Rate     $\pm 8.5V/\mu s$  (typ)
- Gain Bandwidth Product                              20MHz (typ)
- Open Loop Gain ( $R_L = 600\Omega$ )                    118dB (typ)
- Input Bias Current                                        40fA (typ)
- Input Offset Voltage                                    0.3mV (typ)
- PSRR    103dB (typ)

### Features

- Rail-to-rail Input and Output
- Easily drives  $10k\Omega$  loads to within 10mV of each power supply voltage
- Optimized for superior audio signal fidelity
- Output short circuit protection

### Applications

- Ultra high quality portable audio amplification
- High fidelity preamplifiers
- High fidelity multimedia
- State of the art phono pre amps
- High performance professional audio
- High fidelity equalization and crossover networks
- High performance line drivers
- High performance line receivers
- High fidelity active filters
- DAC I-V converter
- ADC front-end signal conditioning

### Typical Connection, Pinout, and Package Marking

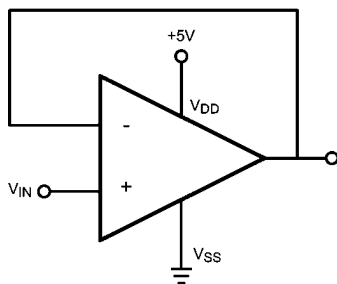
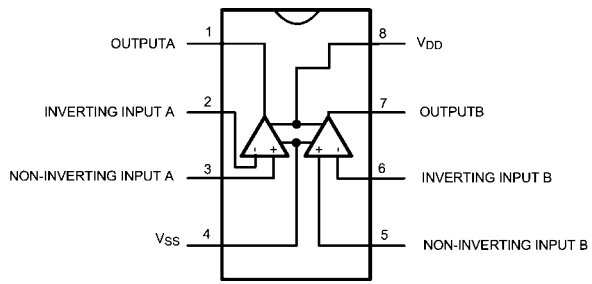

FIGURE 1. Buffer Amplifier

20204909



Order Number LME49721MA  
Se NS Package Number M08A

20204910

**Package Marking**

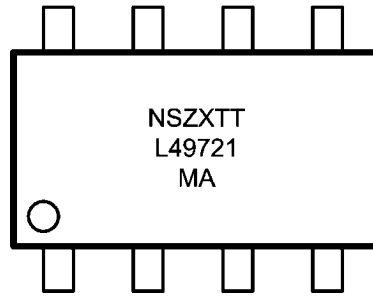

202049x1

NS = National Logo  
 Z = Assembly plant code  
 X = 1 Digit date code  
 TT = Lot traceability  
 L49721 = LME49721  
 MA = Narrow SOIC package code

**Ordering Information**

Package	Part Number	Package Marking	Transport Media	NSC Drawing
8 – Pin Narrow SOIC	LME49721MA/NOPB	L49721	95 units/Rail	M08A
	LME49721MAE/NOPB		250 units Tape and Reel	
	LME49721MAX/NOPB		2.5K units Tape and Reel	

**Absolute Maximum Ratings** (Note 1, Note

2)

If Military/Aerospace specified devices are required, please contact the National Semiconductor Sales Office/ Distributors for availability and specifications.

Power Supply Voltage ( $V_S = V^+ - V^-$ )	6V
Storage Temperature	-65°C to 150°C
Input Voltage	(V-) - 0.7V to (V+) + 0.7V
Output Short Circuit (Note 3)	Continuous

Power Dissipation	Internally Limited
ESD Rating (Note 4)	2000V
ESD Rating (Note 5)	200V
Junction Temperature	150°C
Thermal Resistance $\theta_{JA}$ (SO)	165°C/W
Temperature Range $T_{MIN} \leq T_A \leq T_{MAX}$	-40°C $\leq T_A \leq$ 85°C
Supply Voltage Range	2.2V $\leq V_S \leq$ 5.5V

**Electrical Characteristics for the LME49721** The following specifications apply for the circuit shown in Figure 1.  $V_S = 5V$ ,  $R_L = 10k\Omega$ ,  $R_{SOURCE} = 10\Omega$ ,  $f_{IN} = 1kHz$ , and  $T_A = 25^\circ C$ , unless otherwise specified.

Symbol	Parameter	Conditions	LME49721		Units (Limits)
			Typical	Limit	
			(Note 6)	(Note 7)	
THD+N	Total Harmonic Distortion + Noise	$A_V = +1$ , $V_{OUT} = 2V_{p-p}$ , $R_L = 2k\Omega$ $R_L = 600\Omega$	0.0002 0.0002	0.001	% (max)
IMD	Intermodulation Distortion	$A_V = +1$ , $V_{OUT} = 2V_{p-p}$ , Two-tone, 60Hz & 7kHz 4:1	0.0004		%
GBWP	Gain Bandwidth Product		20	15	MHz (min)
SR	Slew Rate	$A_V = +1$	8.5		V/ $\mu$ s (min)
FPBW	Full Power Bandwidth	$V_{OUT} = 1V_{p-p}$ , -3dB referenced to output magnitude at $f = 1kHz$	2.2		MHz
$t_s$	Settling time	$A_V = 1$ , 4V step 0.1% error range	800		ns
$e_n$	Equivalent Input Noise Voltage	$f_{BW} = 20Hz$ to 20kHz, A-weighted	.707	1.13	$\mu V_{p-p}$ (max)
	Equivalent Input Noise Density	$f = 1kHz$ A-weighted	4	6	nV/ $\sqrt{Hz}$ (max)
$i_n$	Current Noise Density	$f = 10kHz$	4.0		fA/ $\sqrt{Hz}$
$V_{OS}$	Offset Voltage		0.3	1.5	mV (max)
$\Delta V_{OS}/\Delta Temp$	Average Input Offset Voltage Drift vs Temperature	40°C $\leq T_A \leq$ 85°C	1.1		$\mu V/^\circ C$
PSRR	Average Input Offset Voltage Shift vs Power Supply Voltage		103	85	dB (min)
ISO <sub>CH-CH</sub>	Channel-to-Channel Isolation	$f_{IN} = 1kHz$	117		dB
$I_B$	Input Bias Current	$V_{CM} = V_S/2$	40		fA
$\Delta I_{OS}/\Delta Temp$	Input Bias Current Drift vs Temperature	-40°C $\leq T_A \leq$ 85°C	48		fA/ $^\circ C$
$I_{OS}$	Input Offset Current	$V_{CM} = V_S/2$	60		fA
$V_{IN-CM}$	Common-Mode Input Voltage Range			(V+) - 0.1 (V-) + 0.1	V (min)
CMRR	Common-Mode Rejection	$V_{SS} - 100mV < V_{CM} < V_{DD} + 100mV$	93	70	dB (min)
	1/f Corner Frequency		2000		Hz
$A_{VOL}$	Open Loop Voltage Gain	$V_{SS} - 200mV < V_{OUT} < V_{DD} + 200mV$			
		$R_L = 600\Omega$	118	100	dB (min)
		$R_L = 2k\Omega$	122		dB (min)
		$R_L = 10k\Omega$	130	115	dB (min)

Symbol	Parameter	Conditions	LME49721		Units (Limits)
			Typical	Limit	
			(Note 6)	(Note 7)	
V <sub>OUTMIN</sub>	Output Voltage Swing	R <sub>L</sub> = 600Ω	V <sub>DD</sub> – 30mV	V <sub>DD</sub> – 80mV	V (min)
			V <sub>SS</sub> + 30mV	V <sub>SS</sub> + 80mV	V (min)
		R <sub>L</sub> = 10kΩ, V <sub>S</sub> = 5.0V	V <sub>DD</sub> – 10mV	V <sub>DD</sub> – 20mV	V (min)
			V <sub>SS</sub> + 10mV	V <sub>SS</sub> + 20mV	V (min)
I <sub>OUT</sub>	Output Current	R <sub>L</sub> = 250Ω, V <sub>S</sub> = 5.0V	9.7	9.3	mA (min)
I <sub>OUT-SC</sub>	Short Circuit Current		100		mA
R <sub>OUT</sub>	Output Impedance	f <sub>IN</sub> = 10kHz			Ω
		Closed-Loop	0.01		
		Open-Loop	46		
I <sub>S</sub>	Quiescent Current per Amplifier	I <sub>OUT</sub> = 0mA	2.15	3.25	mA (max)

**Note 1:** “Absolute Maximum Ratings” indicate limits beyond which damage to the device may occur, including inoperability and degradation of device reliability and/or performance. Functional operation of the device and/or non-degradation at the *Absolute Maximum Ratings* or other conditions beyond those indicated in the *Recommended Operating Conditions* is not implied. The *Recommended Operating Conditions* indicate conditions at which the device is functional and the device should not be operated beyond such conditions. All voltages are measured with respect to the ground pin, unless otherwise specified

**Note 2:** The *Electrical Characteristics* tables list guaranteed specifications under the listed *Recommended Operating Conditions* except as otherwise modified or specified by the *Electrical Characteristics Conditions* and/or Notes. Typical specifications are estimations only and are not guaranteed.

**Note 3:** The maximum power dissipation must be derated at elevated temperatures and is dictated by T<sub>JMAX</sub>, θ<sub>JA</sub>, and the ambient temperature, T<sub>A</sub>. The maximum allowable power dissipation is P<sub>DMAX</sub> = (T<sub>JMAX</sub> - T<sub>A</sub>) / θ<sub>JA</sub> or the number given in *Absolute Maximum Ratings*, whichever is lower.

**Note 4:** Human body model, applicable std. JESD22-A114C.

**Note 5:** Machine model, applicable std. JESD22-A115-A.

**Note 6:** Typical values represent most likely parametric norms at T<sub>A</sub> = +25°C, and at the *Recommended Operation Conditions* at the time of product characterization and are not guaranteed.

**Note 7:** Datasheet min/max specification limits are guaranteed by test or statistical analysis.

# Typical Performance Characteristics

Graphs were taken in dual supply configuration.

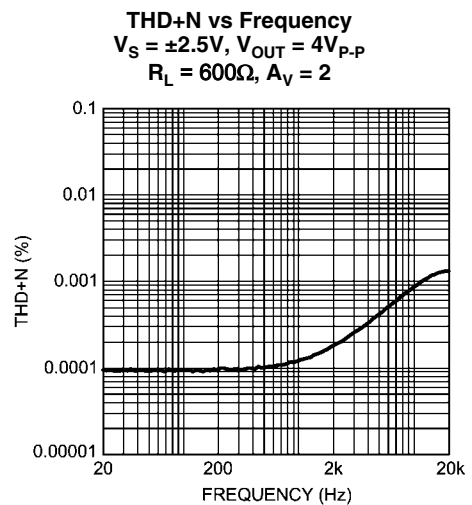
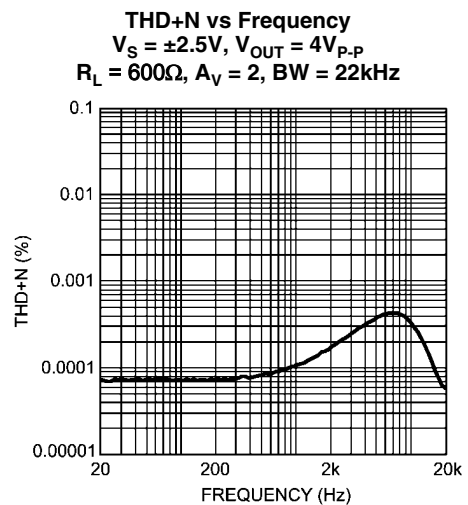
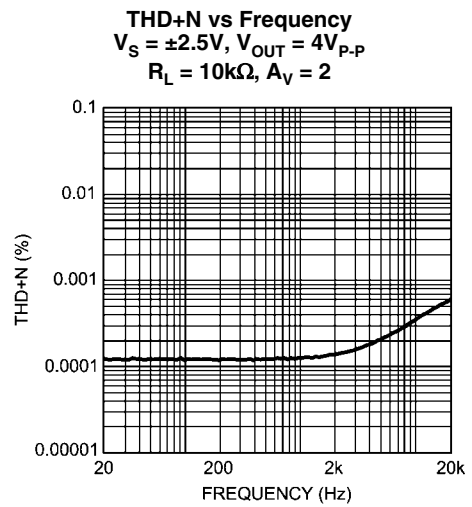
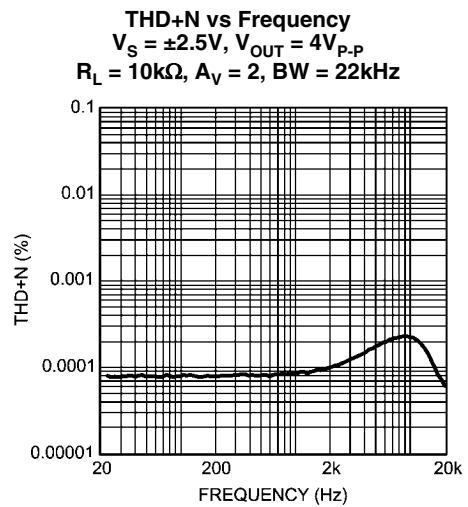
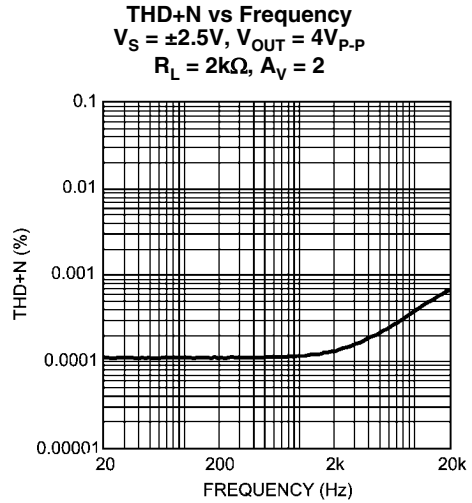
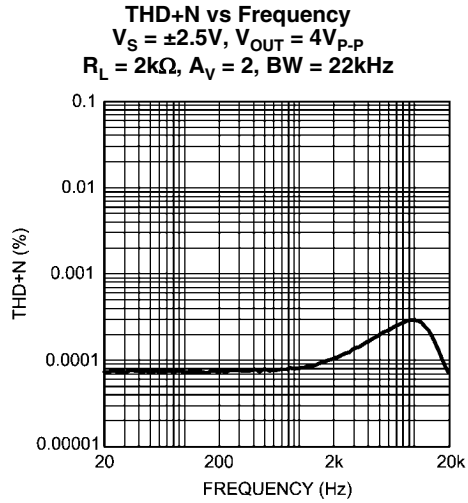

**THD+N vs Frequency**  
 $V_S = \pm 2.75V, V_{OUT} = 4V_{P-P}$   
 $R_L = 2k\Omega, A_V = 2, BW = 22kHz$

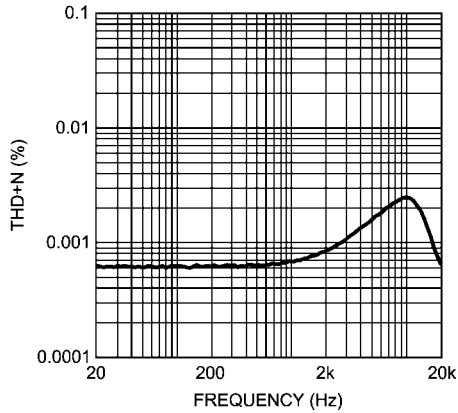

202049u2

**THD+N vs Frequency**  
 $V_S = \pm 2.75V, V_{OUT} = 4V_{P-P}$   
 $R_L = 2k\Omega, A_V = 2$

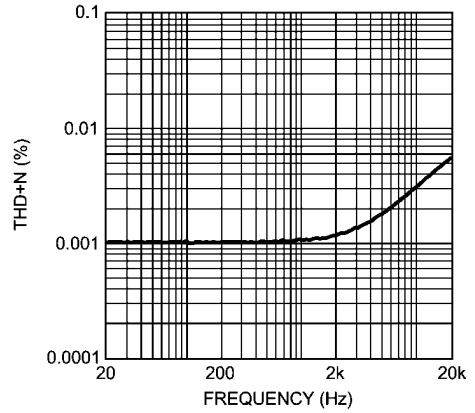

202049u1

**THD+N vs Frequency**  
 $V_S = \pm 2.75V, V_{OUT} = 4V_{P-P}$   
 $R_L = 10k\Omega, A_V = 2, BW = 22kHz$

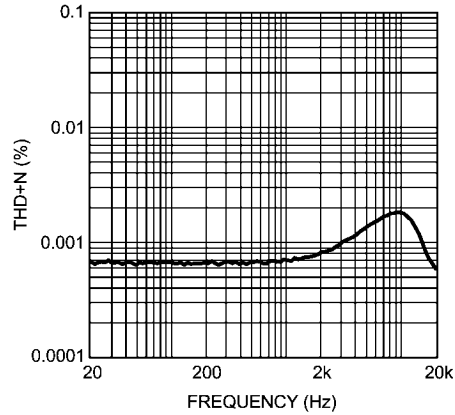

202049u4

**THD+N vs Frequency**  
 $V_S = \pm 2.75V, V_{OUT} = 4V_{P-P}$   
 $R_L = 10k\Omega, A_V = 2$

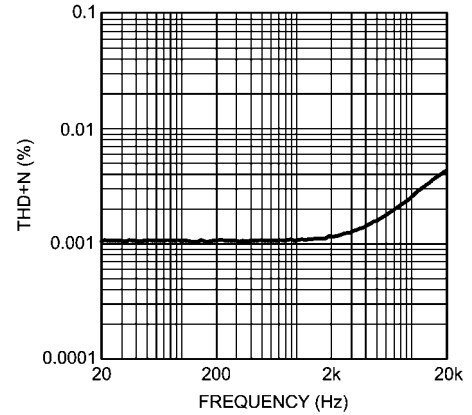

202049u3

**THD+N vs Frequency**  
 $V_S = \pm 2.75V, V_{OUT} = 4V_{P-P}$   
 $R_L = 600\Omega, A_V = 2, BW = 22kHz$

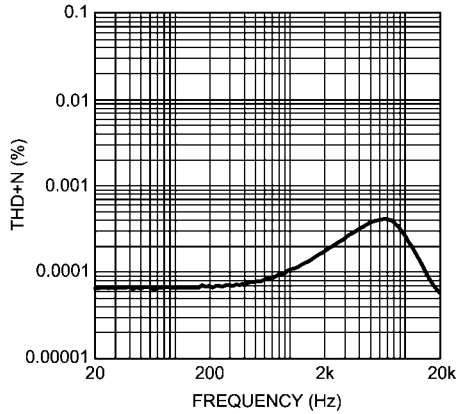

202049u5

**THD+N vs Frequency**  
 $V_S = \pm 2.75V, V_{OUT} = 4V_{P-P}$   
 $R_L = 600\Omega, A_V = 2$

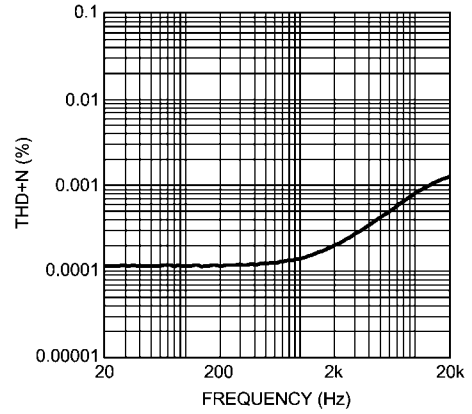

202049u6

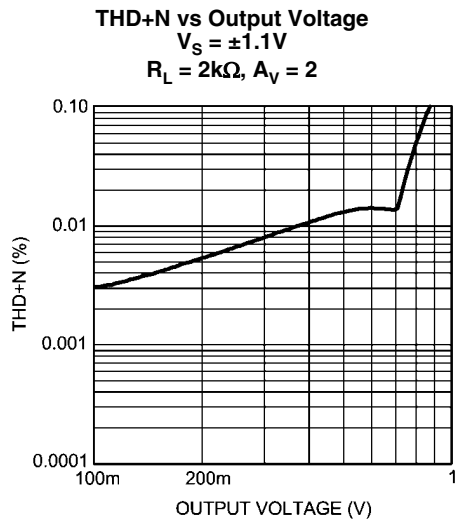

202049u7

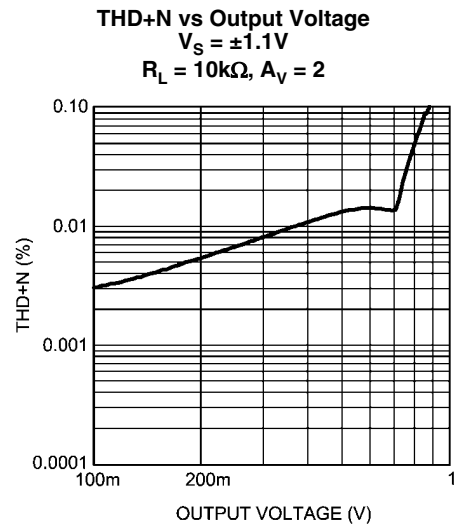

202049u8

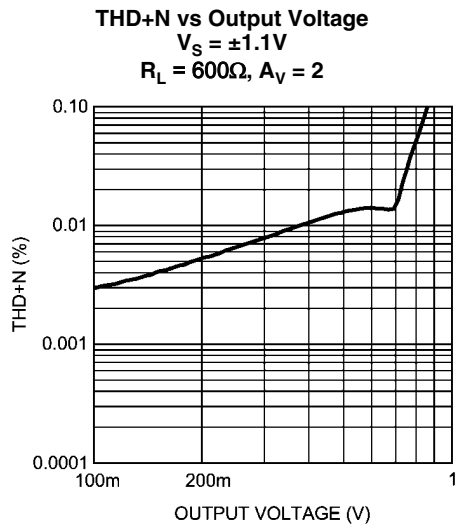

202049u9

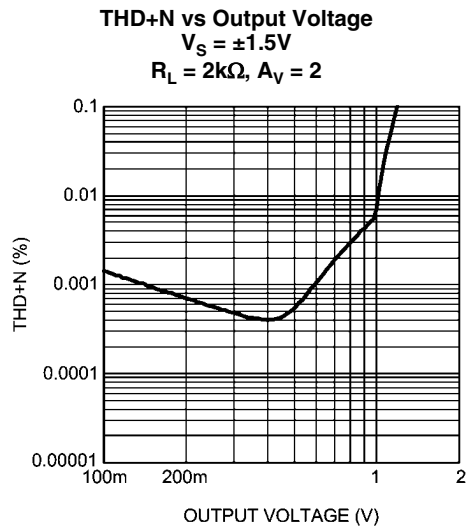

202049v0

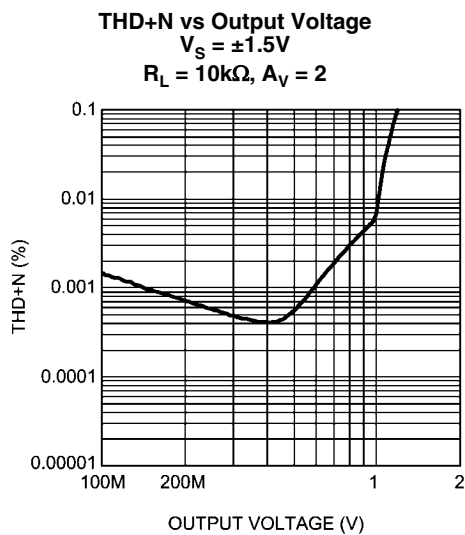

202049v1

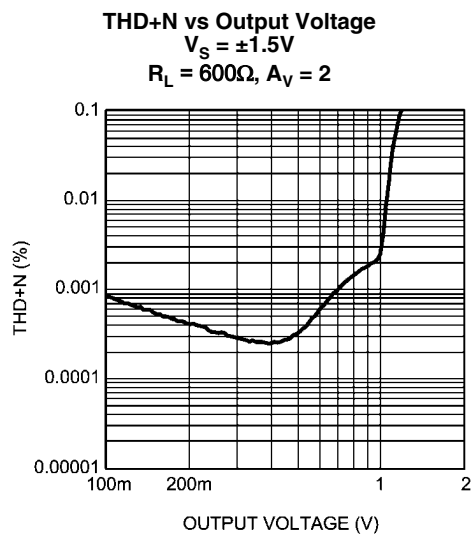

202049v2

**THD+N vs Output Voltage**  
 $V_S = \pm 2.5V$   
 $R_L = 2k\Omega, A_V = 2$

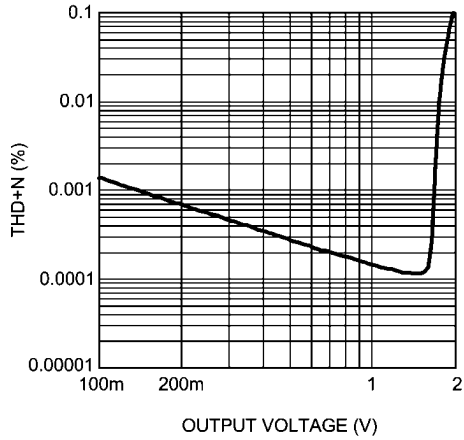

202049v3

**THD+N vs Output Voltage**  
 $V_S = \pm 2.5V$   
 $R_L = 10k\Omega, A_V = 2$

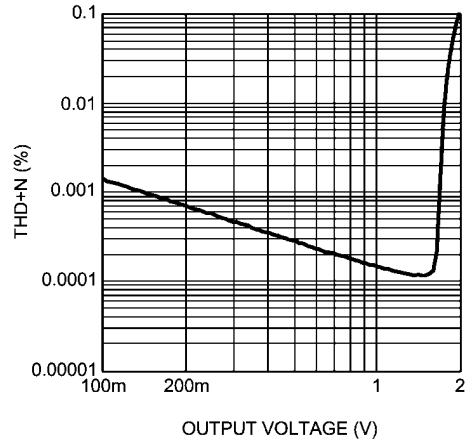

202049v4

**THD+N vs Output Voltage**  
 $V_S = \pm 2.5V$   
 $R_L = 600\Omega, A_V = 2$

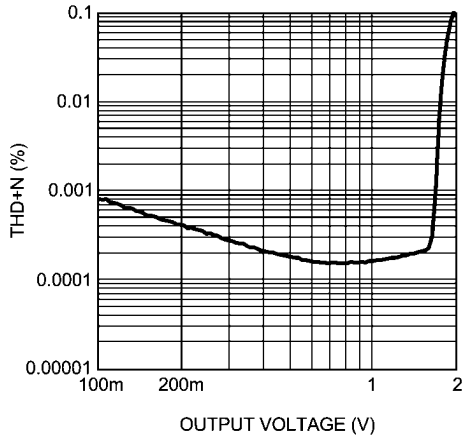

202049v5

**THD+N vs Output Voltage**  
 $V_S = \pm 2.75V$   
 $R_L = 2k\Omega, A_V = 2$

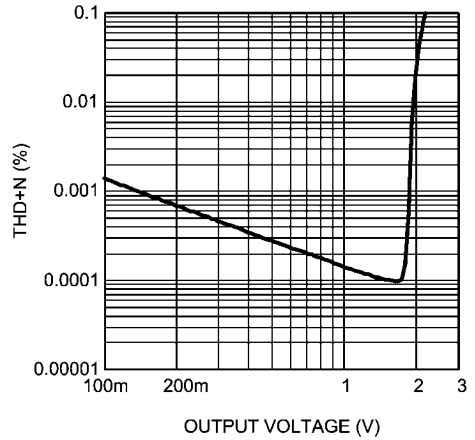

202049v6

**THD+N vs Output Voltage**  
 $V_S = \pm 2.75V$   
 $R_L = 10k\Omega, A_V = 2$

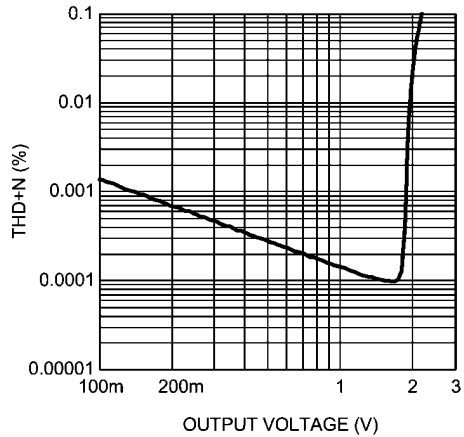

202049v7

**THD+N vs Output Voltage**  
 $V_S = \pm 2.75V$   
 $R_L = 600\Omega, A_V = 2$

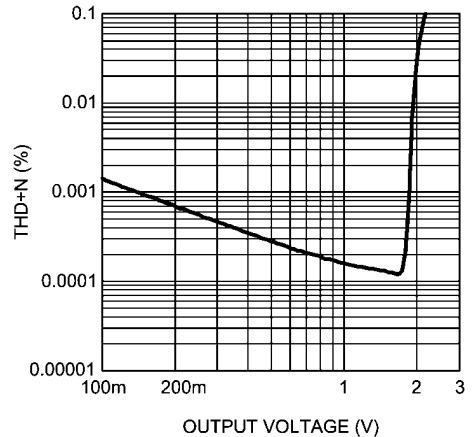

202049v8

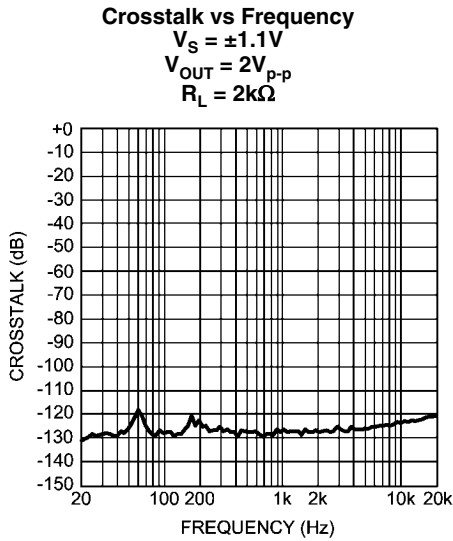

202049r4

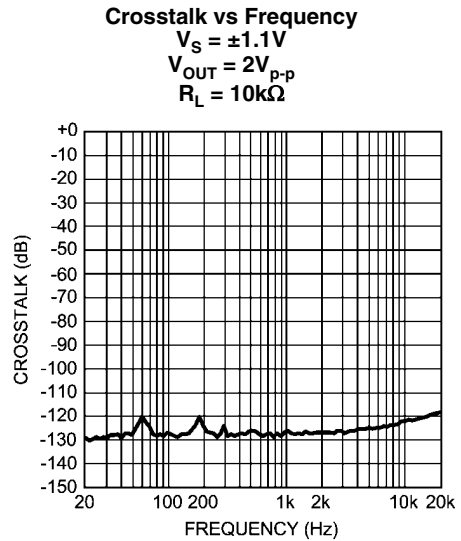

202049r5

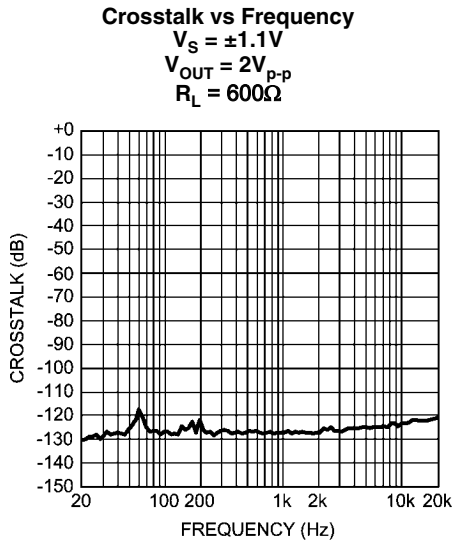

202049r6

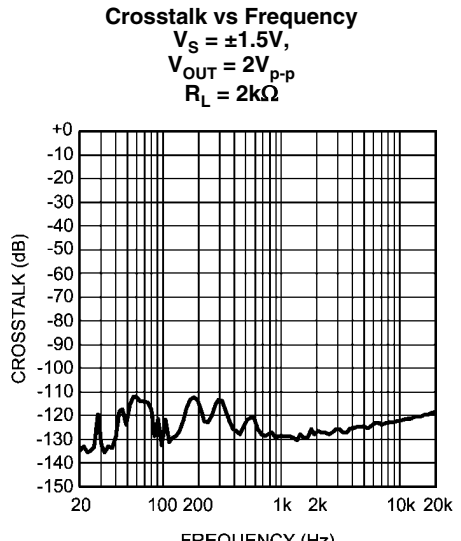

202049k1

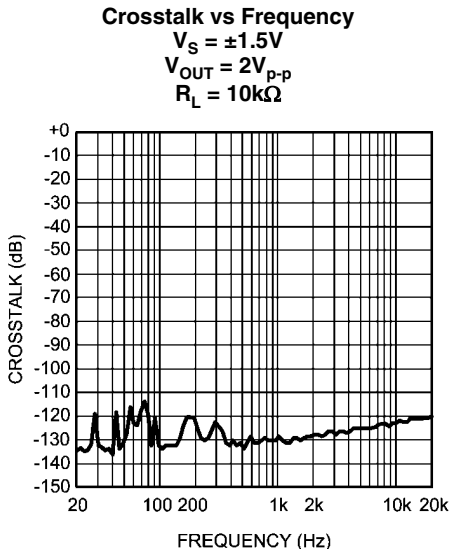

202049k2

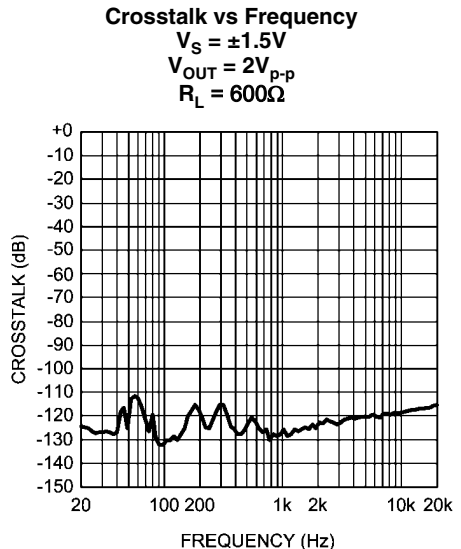

202049k3

**Crosstalk vs Frequency**

$V_S = \pm 2.5V$   
 $V_{OUT} = 4V_{p-p}$   
 $R_L = 2k\Omega$

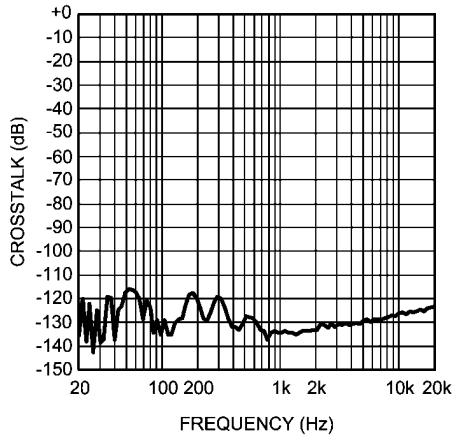

202049k4

**Crosstalk vs Frequency**

$V_S = \pm 2.5V$   
 $V_{OUT} = 4V_{p-p}$   
 $R_L = 10k\Omega$

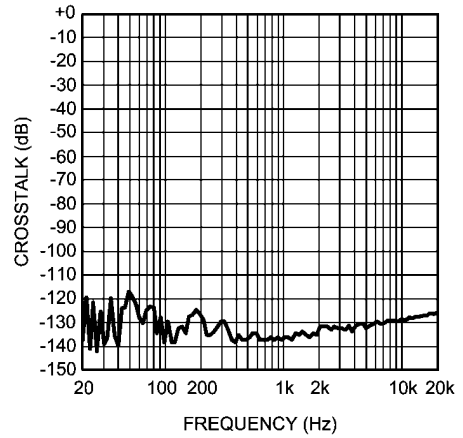

202049k5

**Crosstalk vs Frequency**

$V_S = \pm 2.5V$   
 $V_{OUT} = 4V_{p-p}$   
 $R_L = 600\Omega$

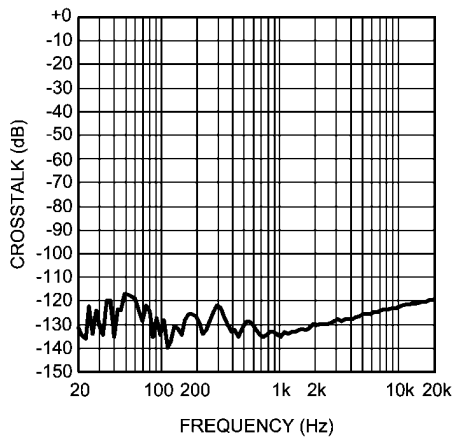

202049k6

**Crosstalk vs Frequency**

$V_S = \pm 2.75V$   
 $V_{OUT} = 4V_{p-p}$   
 $R_L = 2k\Omega$

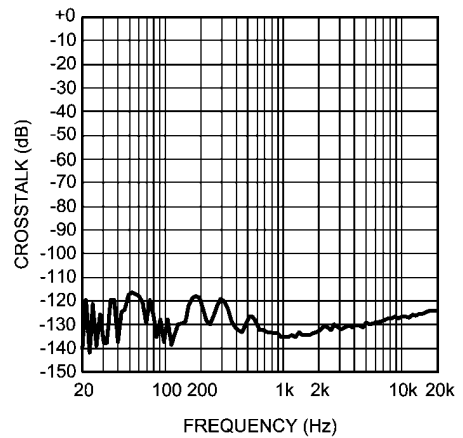

202049k7

**Crosstalk vs Frequency**

$V_S = \pm 2.75V$   
 $V_{OUT} = 4V_{p-p}$   
 $R_L = 10k\Omega$

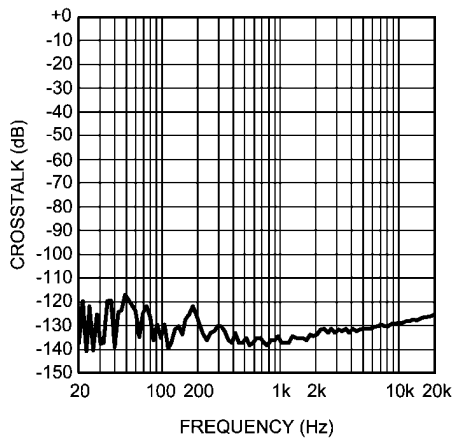

202049k8

**Crosstalk vs Frequency**

$V_S = \pm 2.75V$   
 $V_{OUT} = 4V_{p-p}$   
 $R_L = 600\Omega$

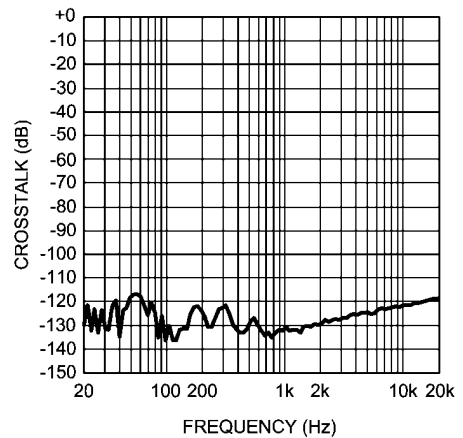

202049k9

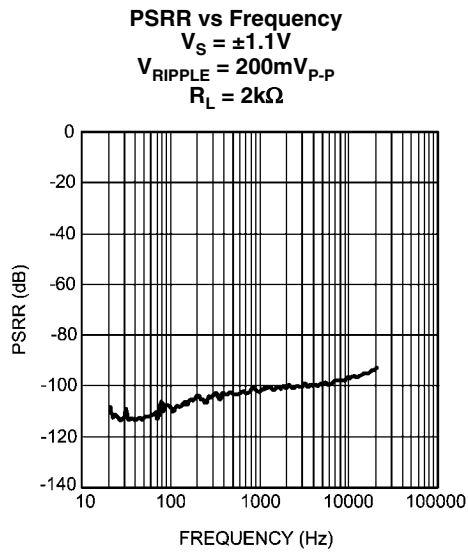

202049v9

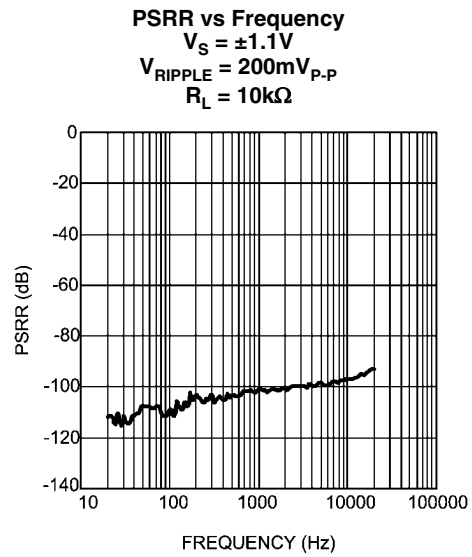

202049w0

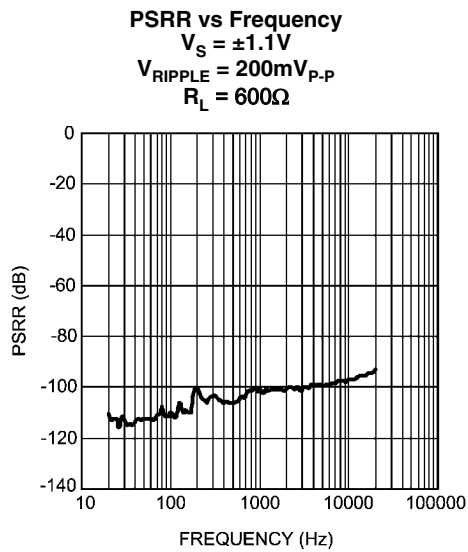

202049w1

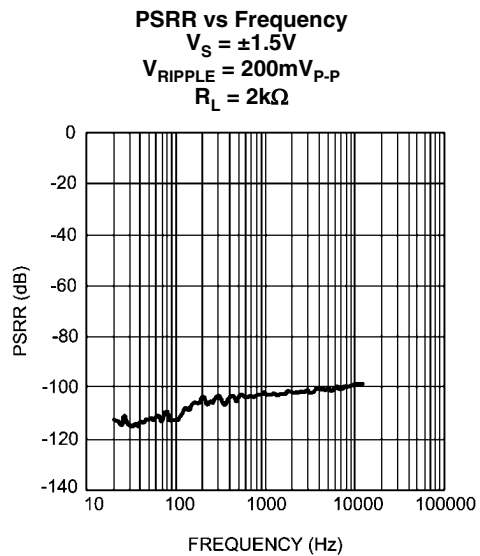

202049w2

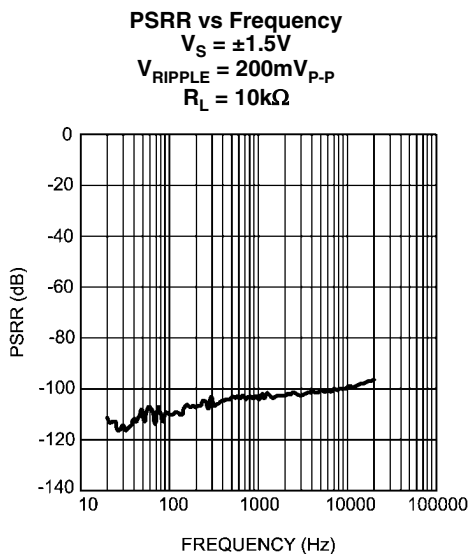

202049w3

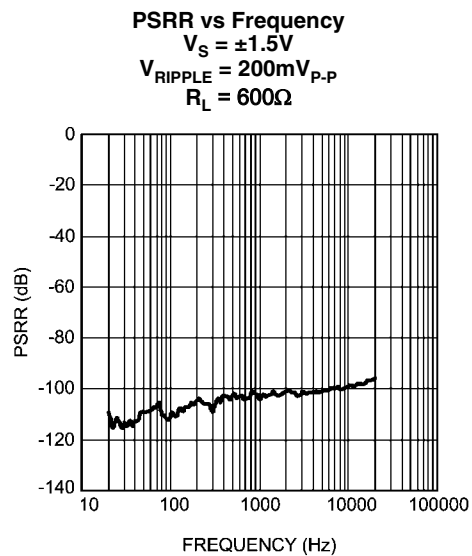

202049x4

**PSRR vs Frequency**

$V_S = \pm 2.5V$

$V_{RIPPLE} = 200mV_{P-P}$

$R_L = 2k\Omega$

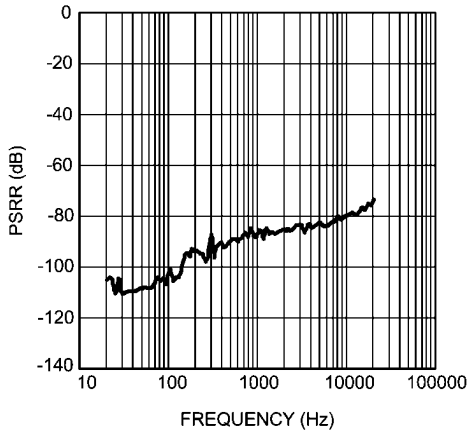

202049w5

**PSRR vs Frequency**

$V_S = \pm 2.5V$

$V_{RIPPLE} = 200mV_{P-P}$

$R_L = 10k\Omega$

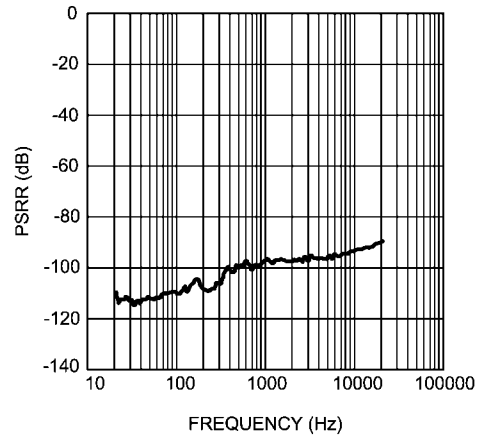

202049w6

**PSRR vs Frequency**

$V_S = \pm 2.5V$

$V_{RIPPLE} = 200mV_{P-P}$

$R_L = 600\Omega$

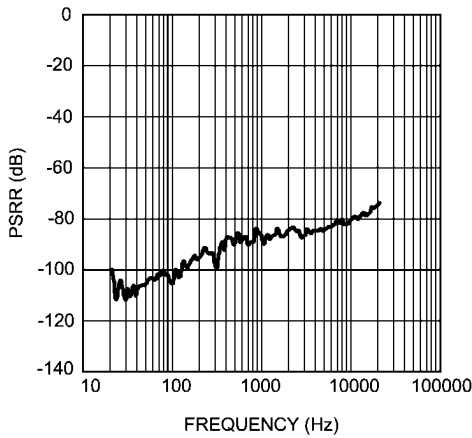

202049w7

**PSRR vs Frequency**

$V_S = \pm 2.75V$

$V_{RIPPLE} = 200mV_{P-P}$

$R_L = 2k\Omega$

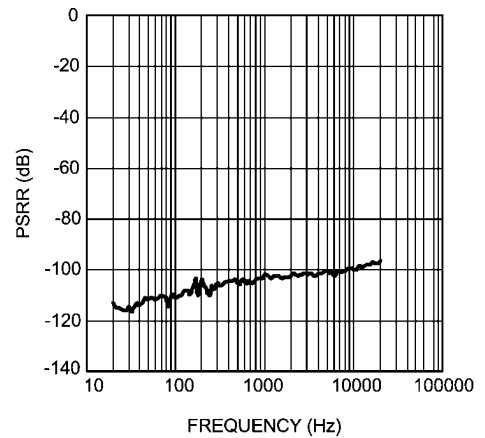

202049w8

**PSRR vs Frequency**

$V_S = \pm 2.75V$

$V_{RIPPLE} = 200mV_{P-P}$

$R_L = 10k\Omega$

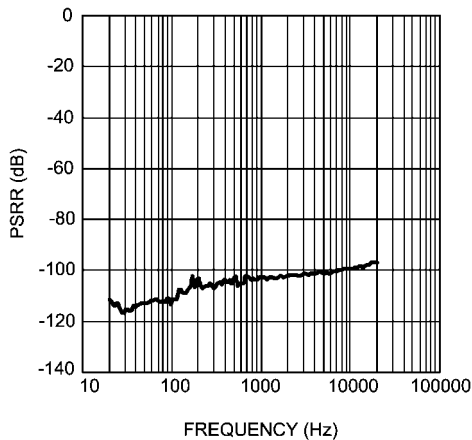

202049w9

**PSRR vs Frequency**

$V_S = \pm 2.75V$

$V_{RIPPLE} = 200mV_{P-P}$

$R_L = 600\Omega$

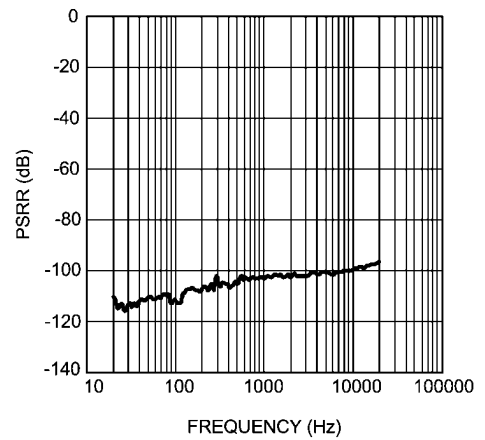

202049x0

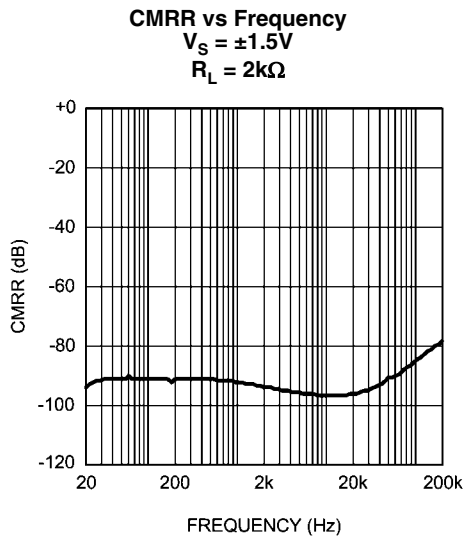

20204913

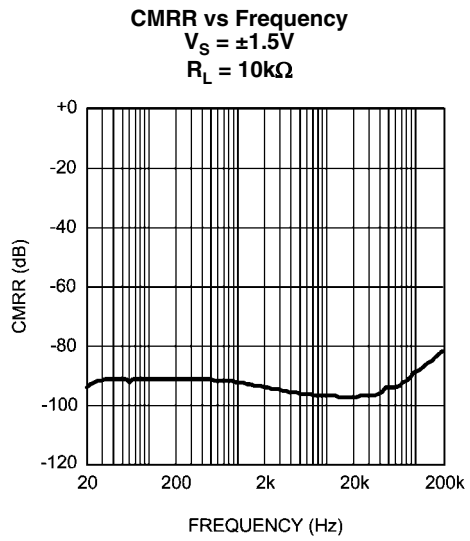

20204914

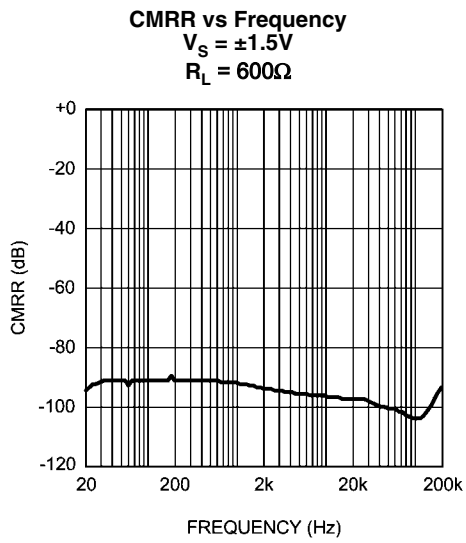

20204915

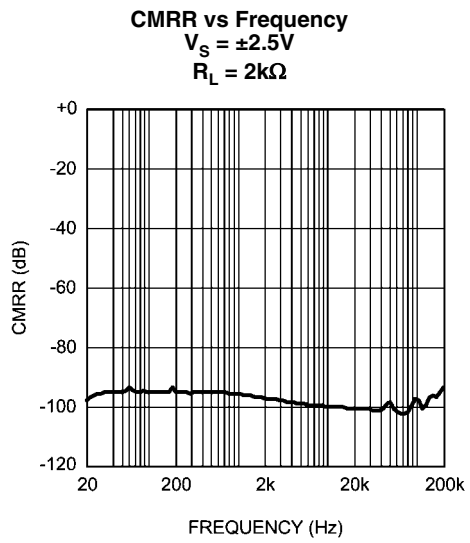

20204916

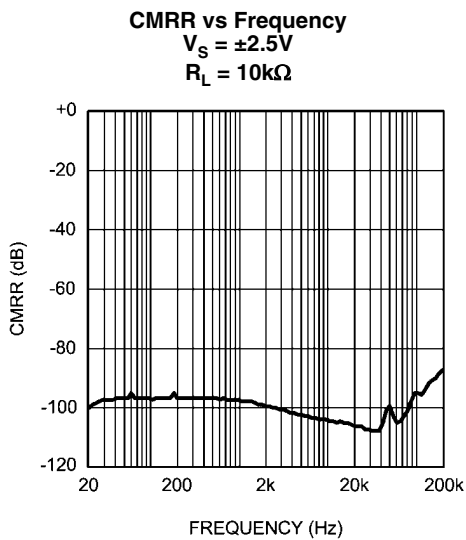

20204917

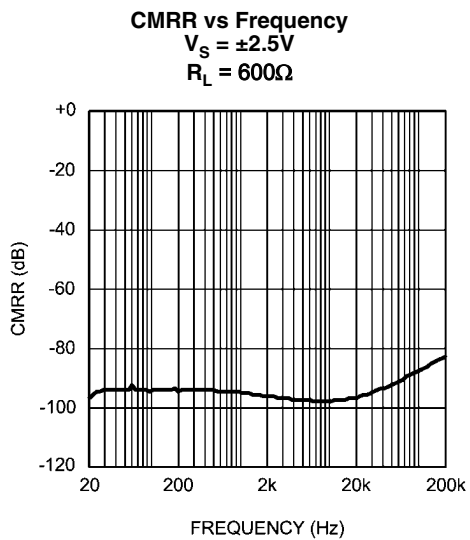

20204918

**CMRR vs Frequency**  
 $V_S = \pm 2.75V$   
 $R_L = 2k\Omega$

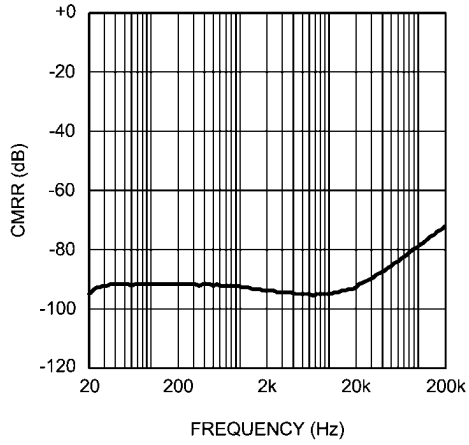

202049i9

**CMRR vs Frequency**  
 $V_S = \pm 2.75V$   
 $R_L = 10k\Omega$

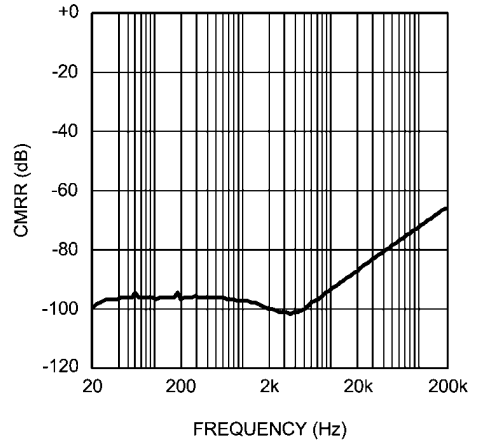

202049m0

**CMRR vs Frequency**  
 $V_S = \pm 2.75V$   
 $R_L = 600\Omega$

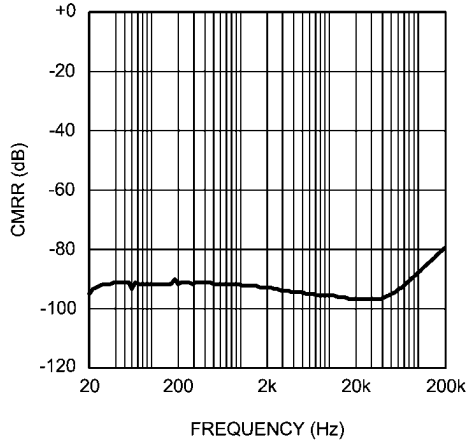

202049m1

**Output Voltage Swing Neg vs Power Supply**  
 $R_L = 2k\Omega$

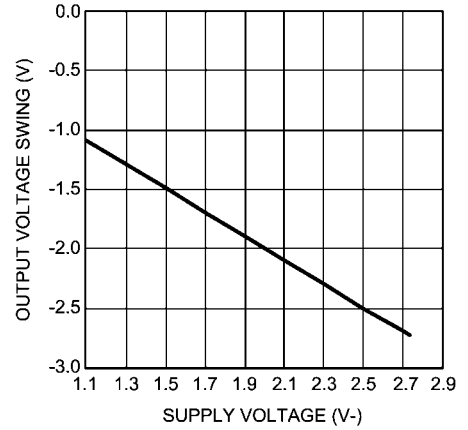

202049s9

**Output Voltage Swing Neg vs Power Supply**  
 $R_L = 10k\Omega$

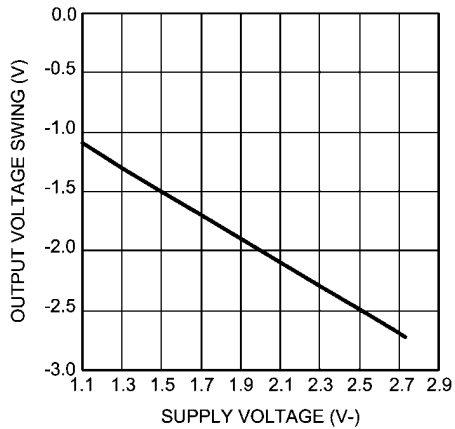

202049t0

**Output Voltage Swing Neg vs Power Supply**  
 $R_L = 600\Omega$

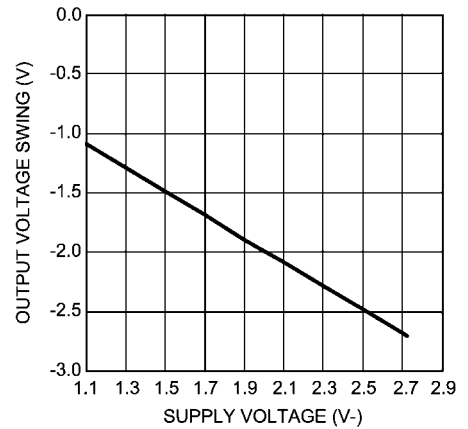

202049t1

**Output Voltage Swing Pos vs Power Supply**  
 $R_L = 2k\Omega$

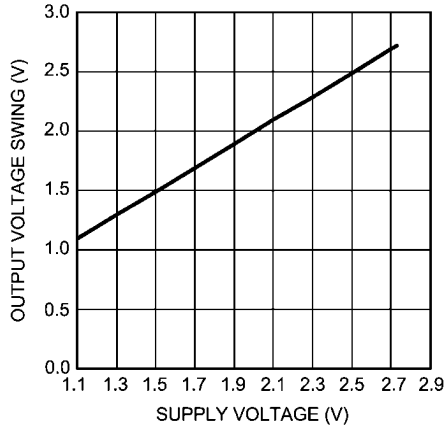

20204912

**Output Voltage Swing Pos vs Power Supply**  
 $R_L = 10k\Omega$

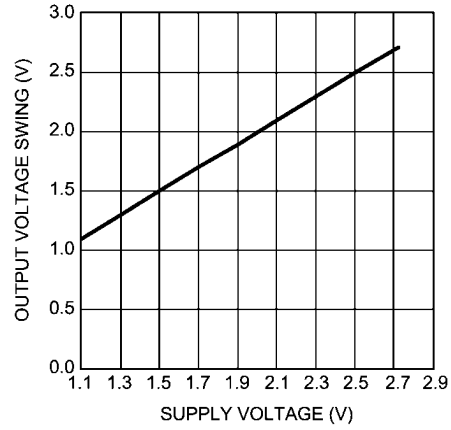

20204913

**Output Voltage Swing Pos vs Power Supply**  
 $R_L = 600\Omega$

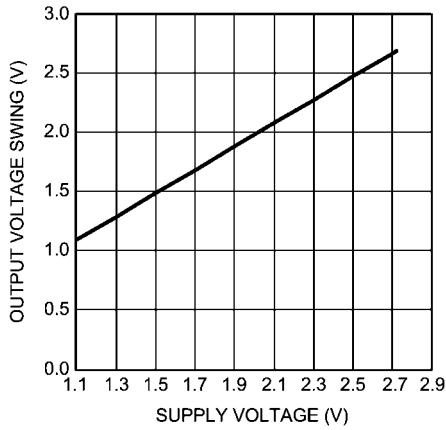

20204914

**Supply Current per amplifier vs Power Supply**  
 $R_L = 2k\Omega$ , Dual Supply

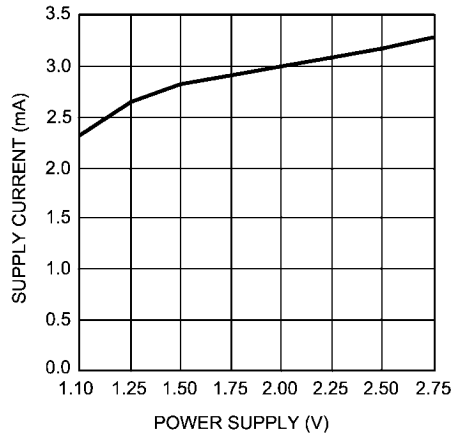

20204953

**Supply Current per amplifier vs Power Supply**  
 $R_L = 10k\Omega$ , Dual Supply

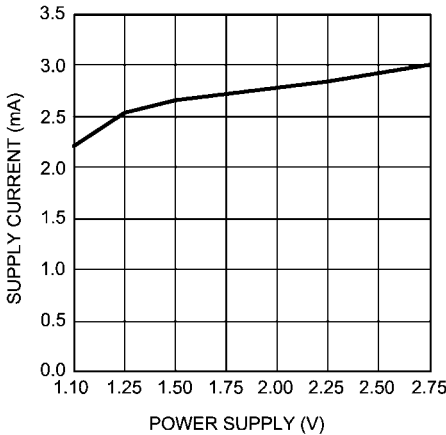

20204954

**Supply Current per amplifier vs Power Supply**  
 $R_L = 600\Omega$ , Dual Supply

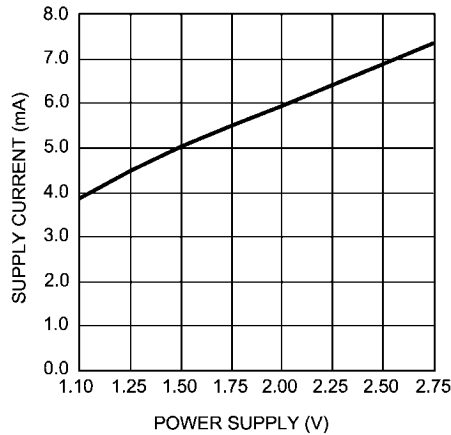

20204956

## Application Information

### DISTORTION MEASUREMENTS

The vanishingly low residual distortion produced by LME49721 is below the capabilities of all commercially available equipment. This makes distortion measurements just slightly more difficult than simply connecting a distortion meter to the amplifier's inputs and outputs. The solution, however, is quite simple: an additional resistor. Adding this resistor extends the resolution of the distortion measurement equipment.

The LME49721's low residual is an input referred internal error. As shown in Figure 1, adding the  $10\Omega$  resistor connected between the amplifier's inverting and non-inverting inputs

changes the amplifier's noise gain. The result is that the error signal (distortion) is amplified by a factor of 101. Although the amplifier's closed-loop gain is unaltered, the feedback available to correct distortion errors is reduced by 101. To ensure minimum effects on distortion measurements, keep the value of  $R_1$  low as shown in Figure 1.

This technique is verified by duplicating the measurements with high closed loop gain and/or making the measurements at high frequencies. Doing so, produces distortion components that are within equipments capabilities. This datasheet's THD+N and IMD values were generated using the above described circuit connected to an Audio Precision System Two Cascade.

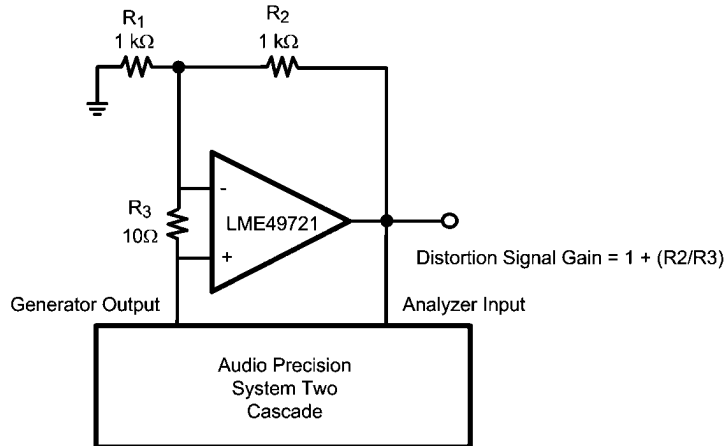

202049x2

FIGURE 1. THD+N and IMD Distortion Test Circuit with  $A_V = 2$

### OPERATING RATINGS AND BASIC DESIGN GUIDELINES

The LME49721 has a supply voltage range from +2.2V to +5.5V single supply or  $\pm 1.1$  to  $\pm 2.75$ V dual supply.

Bypassed capacitors for the supplies should be placed as close to the amplifier as possible. This will help minimize any inductance between the power supply and the supply pins. In addition to a  $10\mu\text{F}$  capacitor, a  $0.1\mu\text{F}$  capacitor is also recommended in CMOS amplifiers.

The amplifier's inputs lead lengths should also be as short as possible. If the op amp does not have a bypass capacitor, it may oscillate.

### BASIC AMPLIFIER CONFIGURATIONS

The LME49721 may be operated with either a single supply or dual supplies. Figure 2 shows the typical connection for a single supply inverting amplifier. The output voltage for a single supply amplifier will be centered around the common-mode voltage  $V_{CM}$ . Note, the voltage applied to the  $V_{CM}$  insures the output stays above ground. Typically, the  $V_{CM}$

should be equal to  $V_{DD}/2$ . This is done by putting a resistor divider ckt at this node, see Figure 2.

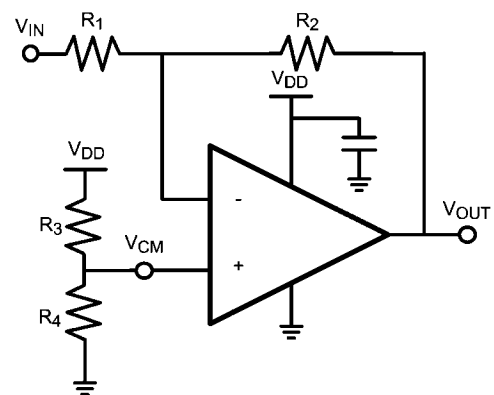

202049n3

FIGURE 2. Single Supply Inverting Op Amp

Figure 3 shows the typical connection for a dual supply inverting amplifier. The output voltage is centered on zero.

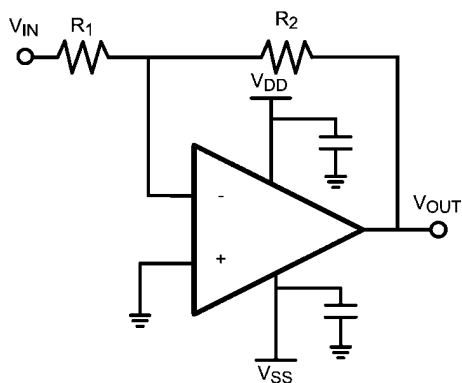

202049n2

**FIGURE 3. Dual Supply Inverting Op Amp**

Figure 4 shows the typical connection for the Buffer Amplifier or also called a Voltage Follower. A Buffer Amplifier can be used to solve impedance matching problems, to reduce pow-

er consumption in the source, or to drive heavy loads. The input impedance of the op amp is very high. Therefore, the input of the op amp does not load down the source. The output impedance on the other hand is very low. It allows the load to either supply or absorb energy to a circuit while a secondary voltage source dissipates energy from a circuit. The Buffer is a unity stable amplifier,  $1V/V$ . Although the feedback loop is tied from the output of the amplifier to the inverting input, the gain is still positive. Note, if a positive feedback is used, the amplifier will most likely drive to either rail at the output.

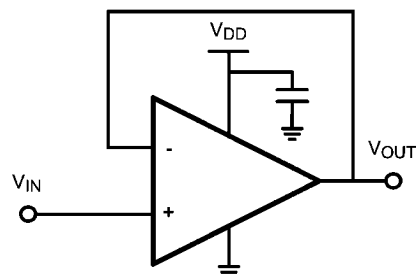

202049n1

**FIGURE 4. Buffer**

# Typical Applications

**ANAB Preamp**

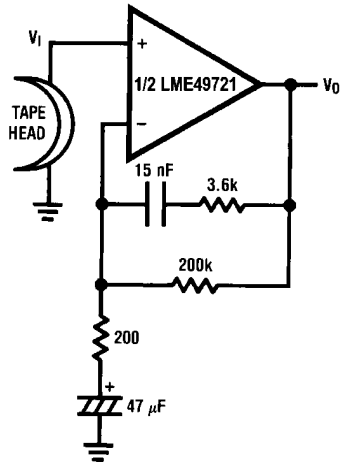

202049n4

$A_V = 34.5$   
 $F = 1 \text{ kHz}$   
 $E_n = 0.38 \mu\text{V}$   
 A Weighted

**NAB Preamp Voltage Gain vs Frequency**

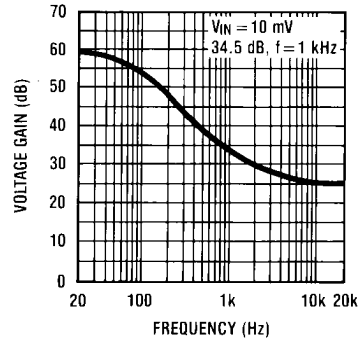

202049n5

**Balanced to Single Ended Converter**

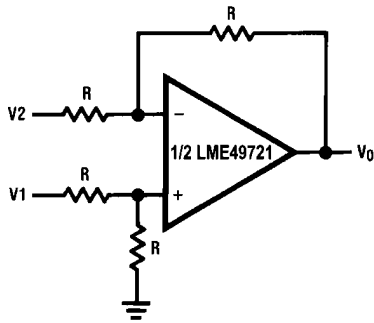

202049n6

$V_O = V1 - V2$

**Adder/Subtractor**

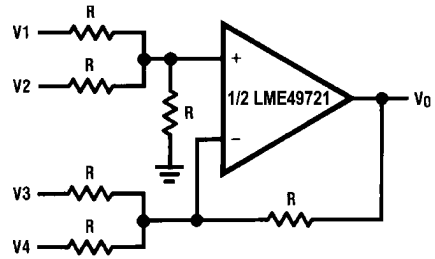

202049n7

$V_O = V1 + V2 - V3 - V4$

**Sine Wave Oscillator**

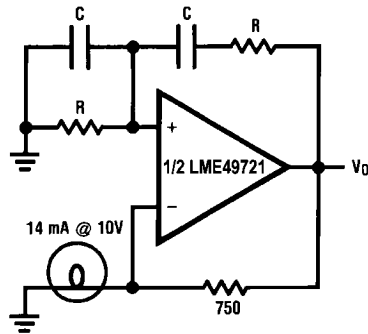

202049n8

$f_o = \frac{1}{2\pi RC}$



AC/DC Converter

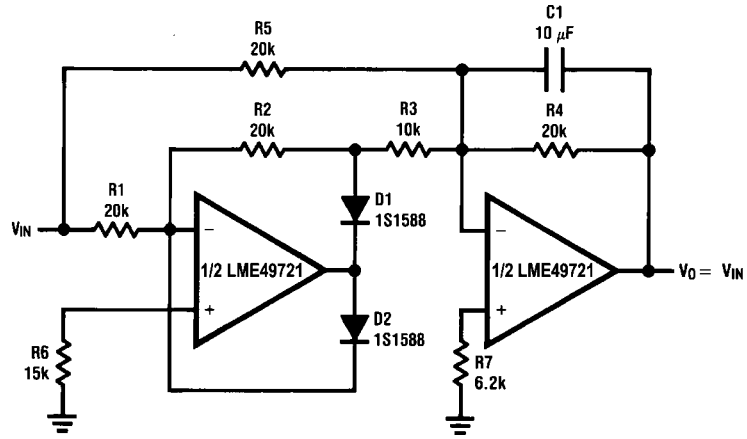

202049o2

2 Channel Panning Circuit (Pan Pot)

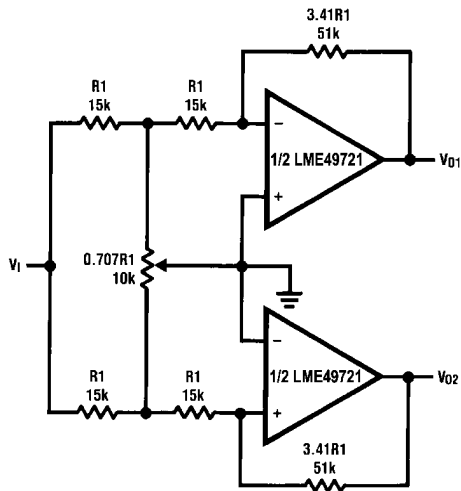

202049o3

Line Driver

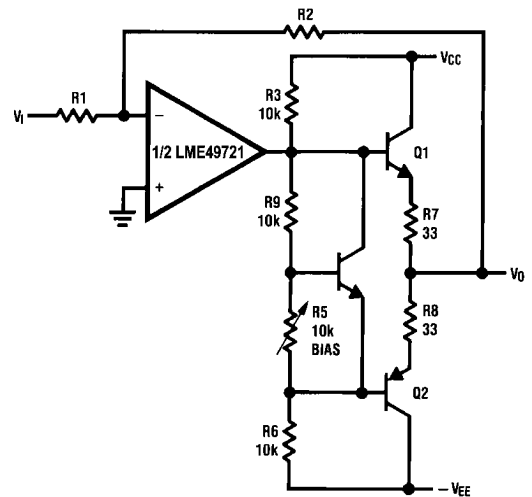

202049o4

**Tone Control**

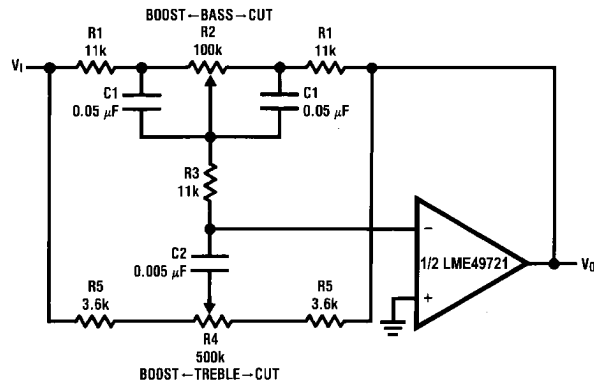

202049o5

$$f_L = \frac{1}{2\pi R_2 C_1}, f_{LB} = \frac{1}{2\pi R_1 C_1}$$

$$f_H = \frac{1}{2\pi R_5 C_2}, f_{HB} = \frac{1}{2\pi (R_1 + R_5 + 2R_3) C_2}$$

Illustration is:

$f_L = 32 \text{ Hz}$ ,  $f_{LB} = 320 \text{ Hz}$   
 $f_H = 11 \text{ kHz}$ ,  $f_{HB} = 1.1 \text{ kHz}$

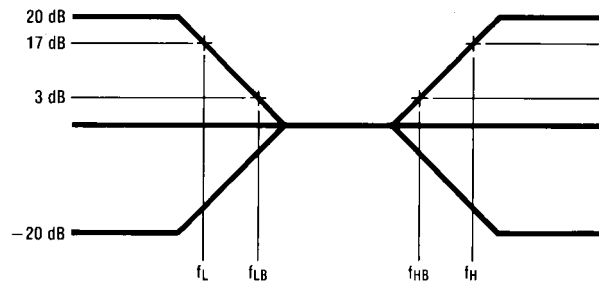

202049o6

**RIAA Preamp**

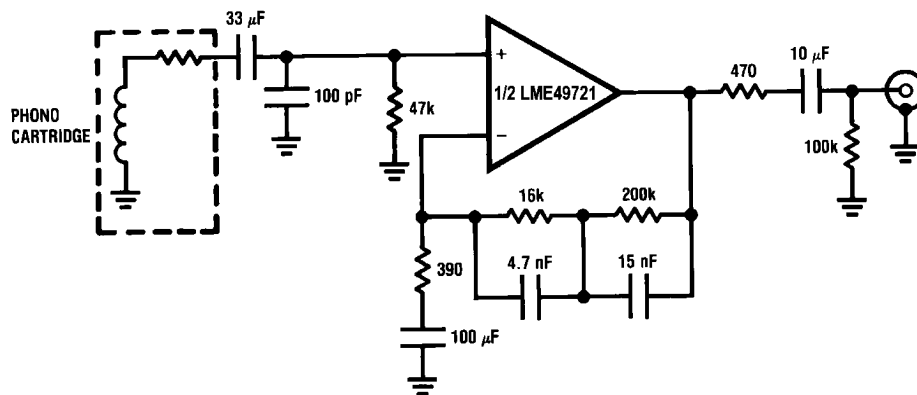

202049o8

$A_v = 35 \text{ dB}$   
 $E_n = 0.33 \mu\text{V}$   
 $S/N = 90 \text{ dB}$   
 $f = 1 \text{ kHz}$   
 A Weighted  
 A Weighted,  $V_{IN} = 10 \text{ mV}$   
 @  $f = 1 \text{ kHz}$

## Balanced Input Mic Amp

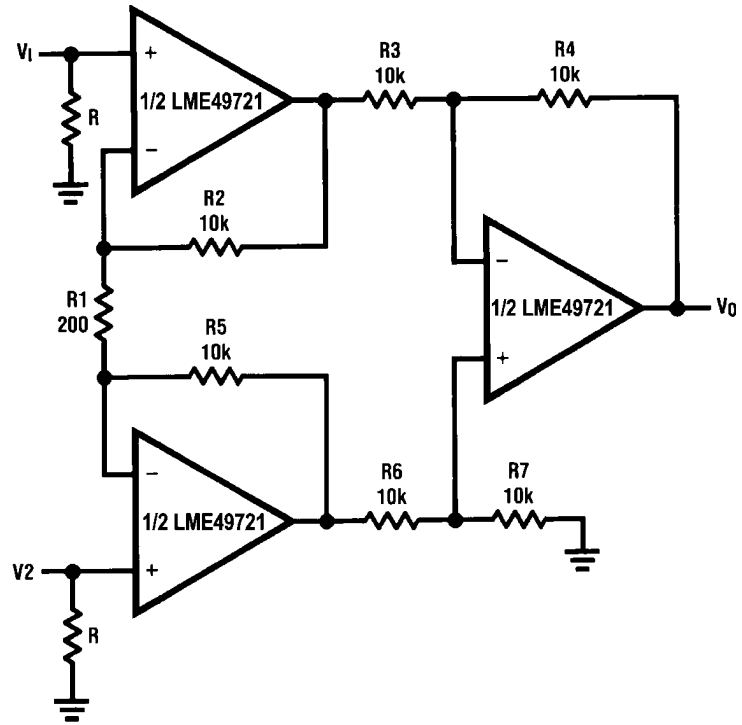

20204907

If  $R2 = R5$ ,  $R3 = R6$ ,  $R4 = R7$

$$V_0 = \left(1 + \frac{2R_2}{R_1}\right) \frac{R_4}{R_3} (V_2 - V_1)$$

Illustration is:

$$V_0 = 101(V_2 - V_1)$$

## 10 Band Graphic Equalizer

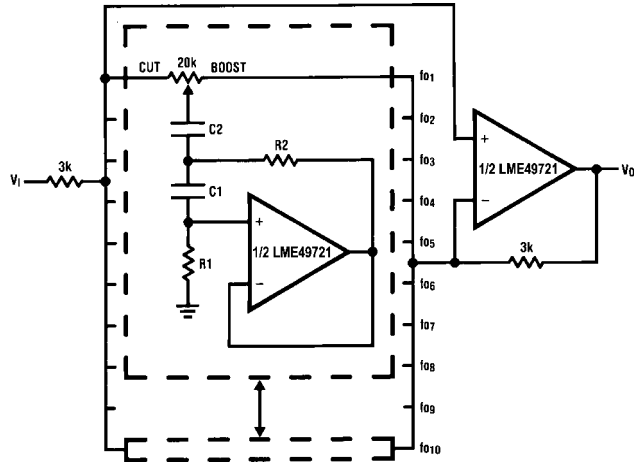

202049p0

fo (Hz)	C <sub>1</sub>	C <sub>2</sub>	R <sub>1</sub>	R <sub>2</sub>
32	0.12 $\mu$ F	4.7 $\mu$ F	75k $\Omega$	500 $\Omega$
64	0.056 $\mu$ F	3.3 $\mu$ F	68k $\Omega$	510 $\Omega$
125	0.033 $\mu$ F	1.5 $\mu$ F	62k $\Omega$	510 $\Omega$
250	0.015 $\mu$ F	0.82 $\mu$ F	68k $\Omega$	470 $\Omega$
500	8200pF	0.39 $\mu$ F	62k $\Omega$	470 $\Omega$
1k	3900pF	0.22 $\mu$ F	68k $\Omega$	470 $\Omega$
2k	2000pF	0.1 $\mu$ F	68k $\Omega$	470 $\Omega$
4k	1100pF	0.056 $\mu$ F	62k $\Omega$	470 $\Omega$
8k	510pF	0.022 $\mu$ F	68k $\Omega$	510 $\Omega$
16k	330pF	0.012 $\mu$ F	51k $\Omega$	510 $\Omega$

**Note 8:** At volume of change =  $\pm 12$  dB

Q = 1.7

Reference: "AUDIO/RADIO HANDBOOK", National Semiconductor, 1980, Page 2-61

## Revision History

<b>Rev</b>	<b>Date</b>	<b>Description</b>
1.0	09/26/07	Initial release.
1.1	10/01/07	Input more info under the Buffer Amplifier.
1.2	04/21/10	Added the Ordering Information table.

**Physical Dimensions** inches (millimeters) unless otherwise noted

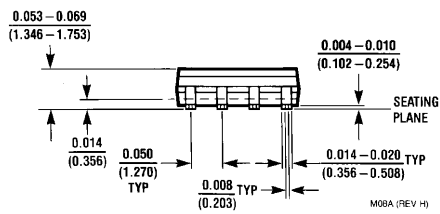
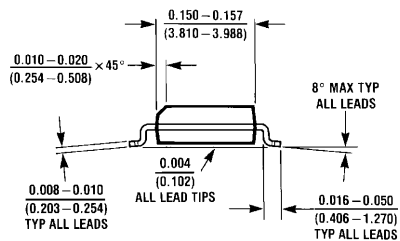
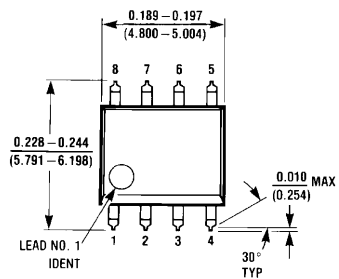

**NS Package M08A**

M08A (REV H)

## Notes

For more National Semiconductor product information and proven design tools, visit the following Web sites at:  
[www.national.com](http://www.national.com)

Products		Design Support	
Amplifiers	<a href="http://www.national.com/amplifiers">www.national.com/amplifiers</a>	WEBENCH® Tools	<a href="http://www.national.com/webench">www.national.com/webench</a>
Audio	<a href="http://www.national.com/audio">www.national.com/audio</a>	App Notes	<a href="http://www.national.com/appnotes">www.national.com/appnotes</a>
Clock and Timing	<a href="http://www.national.com/timing">www.national.com/timing</a>	Reference Designs	<a href="http://www.national.com/refdesigns">www.national.com/refdesigns</a>
Data Converters	<a href="http://www.national.com/adc">www.national.com/adc</a>	Samples	<a href="http://www.national.com/samples">www.national.com/samples</a>
Interface	<a href="http://www.national.com/interface">www.national.com/interface</a>	Eval Boards	<a href="http://www.national.com/evalboards">www.national.com/evalboards</a>
LVDS	<a href="http://www.national.com/lvds">www.national.com/lvds</a>	Packaging	<a href="http://www.national.com/packaging">www.national.com/packaging</a>
Power Management	<a href="http://www.national.com/power">www.national.com/power</a>	Green Compliance	<a href="http://www.national.com/quality/green">www.national.com/quality/green</a>
Switching Regulators	<a href="http://www.national.com/switchers">www.national.com/switchers</a>	Distributors	<a href="http://www.national.com/contacts">www.national.com/contacts</a>
LDOs	<a href="http://www.national.com/ldo">www.national.com/ldo</a>	Quality and Reliability	<a href="http://www.national.com/quality">www.national.com/quality</a>
LED Lighting	<a href="http://www.national.com/led">www.national.com/led</a>	Feedback/Support	<a href="http://www.national.com/feedback">www.national.com/feedback</a>
Voltage References	<a href="http://www.national.com/vref">www.national.com/vref</a>	Design Made Easy	<a href="http://www.national.com/easy">www.national.com/easy</a>
PowerWise® Solutions	<a href="http://www.national.com/powerwise">www.national.com/powerwise</a>	Applications & Markets	<a href="http://www.national.com/solutions">www.national.com/solutions</a>
Serial Digital Interface (SDI)	<a href="http://www.national.com/sdi">www.national.com/sdi</a>	Mil/Aero	<a href="http://www.national.com/milaero">www.national.com/milaero</a>
Temperature Sensors	<a href="http://www.national.com/tempensors">www.national.com/tempensors</a>	SolarMagic™	<a href="http://www.national.com/solarmagic">www.national.com/solarmagic</a>
PLL/VCO	<a href="http://www.national.com/wireless">www.national.com/wireless</a>	PowerWise® Design University	<a href="http://www.national.com/training">www.national.com/training</a>

THE CONTENTS OF THIS DOCUMENT ARE PROVIDED IN CONNECTION WITH NATIONAL SEMICONDUCTOR CORPORATION ("NATIONAL") PRODUCTS. NATIONAL MAKES NO REPRESENTATIONS OR WARRANTIES WITH RESPECT TO THE ACCURACY OR COMPLETENESS OF THE CONTENTS OF THIS PUBLICATION AND RESERVES THE RIGHT TO MAKE CHANGES TO SPECIFICATIONS AND PRODUCT DESCRIPTIONS AT ANY TIME WITHOUT NOTICE. NO LICENSE, WHETHER EXPRESS, IMPLIED, ARISING BY ESTOPPEL OR OTHERWISE, TO ANY INTELLECTUAL PROPERTY RIGHTS IS GRANTED BY THIS DOCUMENT.

TESTING AND OTHER QUALITY CONTROLS ARE USED TO THE EXTENT NATIONAL DEEMS NECESSARY TO SUPPORT NATIONAL'S PRODUCT WARRANTY. EXCEPT WHERE MANDATED BY GOVERNMENT REQUIREMENTS, TESTING OF ALL PARAMETERS OF EACH PRODUCT IS NOT NECESSARILY PERFORMED. NATIONAL ASSUMES NO LIABILITY FOR APPLICATIONS ASSISTANCE OR BUYER PRODUCT DESIGN. BUYERS ARE RESPONSIBLE FOR THEIR PRODUCTS AND APPLICATIONS USING NATIONAL COMPONENTS. PRIOR TO USING OR DISTRIBUTING ANY PRODUCTS THAT INCLUDE NATIONAL COMPONENTS, BUYERS SHOULD PROVIDE ADEQUATE DESIGN, TESTING AND OPERATING SAFEGUARDS.

EXCEPT AS PROVIDED IN NATIONAL'S TERMS AND CONDITIONS OF SALE FOR SUCH PRODUCTS, NATIONAL ASSUMES NO LIABILITY WHATSOEVER, AND NATIONAL DISCLAIMS ANY EXPRESS OR IMPLIED WARRANTY RELATING TO THE SALE AND/OR USE OF NATIONAL PRODUCTS INCLUDING LIABILITY OR WARRANTIES RELATING TO FITNESS FOR A PARTICULAR PURPOSE, MERCHANTABILITY, OR INFRINGEMENT OF ANY PATENT, COPYRIGHT OR OTHER INTELLECTUAL PROPERTY RIGHT.

#### LIFE SUPPORT POLICY

**NATIONAL'S PRODUCTS ARE NOT AUTHORIZED FOR USE AS CRITICAL COMPONENTS IN LIFE SUPPORT DEVICES OR SYSTEMS WITHOUT THE EXPRESS PRIOR WRITTEN APPROVAL OF THE CHIEF EXECUTIVE OFFICER AND GENERAL COUNSEL OF NATIONAL SEMICONDUCTOR CORPORATION.** As used herein:

Life support devices or systems are devices which (a) are intended for surgical implant into the body, or (b) support or sustain life and whose failure to perform when properly used in accordance with instructions for use provided in the labeling can be reasonably expected to result in a significant injury to the user. A critical component is any component in a life support device or system whose failure to perform can be reasonably expected to cause the failure of the life support device or system or to affect its safety or effectiveness.

National Semiconductor and the National Semiconductor logo are registered trademarks of National Semiconductor Corporation. All other brand or product names may be trademarks or registered trademarks of their respective holders.

Copyright© 2010 National Semiconductor Corporation

For the most current product information visit us at [www.national.com](http://www.national.com)



**National Semiconductor Americas Technical Support Center**  
 Email: [support@nsc.com](mailto:support@nsc.com)  
 Tel: 1-800-272-9959

**National Semiconductor Europe Technical Support Center**  
 Email: [europe.support@nsc.com](mailto:europe.support@nsc.com)

**National Semiconductor Asia Pacific Technical Support Center**  
 Email: [ap.support@nsc.com](mailto:ap.support@nsc.com)

**National Semiconductor Japan Technical Support Center**  
 Email: [jpn.feedback@nsc.com](mailto:jpn.feedback@nsc.com)

## IMPORTANT NOTICE

Texas Instruments Incorporated and its subsidiaries (TI) reserve the right to make corrections, modifications, enhancements, improvements, and other changes to its products and services at any time and to discontinue any product or service without notice. Customers should obtain the latest relevant information before placing orders and should verify that such information is current and complete. All products are sold subject to TI's terms and conditions of sale supplied at the time of order acknowledgment.

TI warrants performance of its hardware products to the specifications applicable at the time of sale in accordance with TI's standard warranty. Testing and other quality control techniques are used to the extent TI deems necessary to support this warranty. Except where mandated by government requirements, testing of all parameters of each product is not necessarily performed.

TI assumes no liability for applications assistance or customer product design. Customers are responsible for their products and applications using TI components. To minimize the risks associated with customer products and applications, customers should provide adequate design and operating safeguards.

TI does not warrant or represent that any license, either express or implied, is granted under any TI patent right, copyright, mask work right, or other TI intellectual property right relating to any combination, machine, or process in which TI products or services are used. Information published by TI regarding third-party products or services does not constitute a license from TI to use such products or services or a warranty or endorsement thereof. Use of such information may require a license from a third party under the patents or other intellectual property of the third party, or a license from TI under the patents or other intellectual property of TI.

Reproduction of TI information in TI data books or data sheets is permissible only if reproduction is without alteration and is accompanied by all associated warranties, conditions, limitations, and notices. Reproduction of this information with alteration is an unfair and deceptive business practice. TI is not responsible or liable for such altered documentation. Information of third parties may be subject to additional restrictions.

Resale of TI products or services with statements different from or beyond the parameters stated by TI for that product or service voids all express and any implied warranties for the associated TI product or service and is an unfair and deceptive business practice. TI is not responsible or liable for any such statements.

TI products are not authorized for use in safety-critical applications (such as life support) where a failure of the TI product would reasonably be expected to cause severe personal injury or death, unless officers of the parties have executed an agreement specifically governing such use. Buyers represent that they have all necessary expertise in the safety and regulatory ramifications of their applications, and acknowledge and agree that they are solely responsible for all legal, regulatory and safety-related requirements concerning their products and any use of TI products in such safety-critical applications, notwithstanding any applications-related information or support that may be provided by TI. Further, Buyers must fully indemnify TI and its representatives against any damages arising out of the use of TI products in such safety-critical applications.

TI products are neither designed nor intended for use in military/aerospace applications or environments unless the TI products are specifically designated by TI as military-grade or "enhanced plastic." Only products designated by TI as military-grade meet military specifications. Buyers acknowledge and agree that any such use of TI products which TI has not designated as military-grade is solely at the Buyer's risk, and that they are solely responsible for compliance with all legal and regulatory requirements in connection with such use.

TI products are neither designed nor intended for use in automotive applications or environments unless the specific TI products are designated by TI as compliant with ISO/TS 16949 requirements. Buyers acknowledge and agree that, if they use any non-designated products in automotive applications, TI will not be responsible for any failure to meet such requirements.

Following are URLs where you can obtain information on other Texas Instruments products and application solutions:

### Products

Audio	<a href="http://www.ti.com/audio">www.ti.com/audio</a>
Amplifiers	<a href="http://amplifier.ti.com">amplifier.ti.com</a>
Data Converters	<a href="http://dataconverter.ti.com">dataconverter.ti.com</a>
DLP® Products	<a href="http://www.dlp.com">www.dlp.com</a>
DSP	<a href="http://dsp.ti.com">dsp.ti.com</a>
Clocks and Timers	<a href="http://www.ti.com/clocks">www.ti.com/clocks</a>
Interface	<a href="http://interface.ti.com">interface.ti.com</a>
Logic	<a href="http://logic.ti.com">logic.ti.com</a>
Power Mgmt	<a href="http://power.ti.com">power.ti.com</a>
Microcontrollers	<a href="http://microcontroller.ti.com">microcontroller.ti.com</a>
RFID	<a href="http://www.ti-rfid.com">www.ti-rfid.com</a>
OMAP Mobile Processors	<a href="http://www.ti.com/omap">www.ti.com/omap</a>
Wireless Connectivity	<a href="http://www.ti.com/wirelessconnectivity">www.ti.com/wirelessconnectivity</a>

### Applications

Communications and Telecom	<a href="http://www.ti.com/communications">www.ti.com/communications</a>
Computers and Peripherals	<a href="http://www.ti.com/computers">www.ti.com/computers</a>
Consumer Electronics	<a href="http://www.ti.com/consumer-apps">www.ti.com/consumer-apps</a>
Energy and Lighting	<a href="http://www.ti.com/energy">www.ti.com/energy</a>
Industrial	<a href="http://www.ti.com/industrial">www.ti.com/industrial</a>
Medical	<a href="http://www.ti.com/medical">www.ti.com/medical</a>
Security	<a href="http://www.ti.com/security">www.ti.com/security</a>
Space, Avionics and Defense	<a href="http://www.ti.com/space-avionics-defense">www.ti.com/space-avionics-defense</a>
Transportation and Automotive	<a href="http://www.ti.com/automotive">www.ti.com/automotive</a>
Video and Imaging	<a href="http://www.ti.com/video">www.ti.com/video</a>

TI E2E Community Home Page

[e2e.ti.com](http://e2e.ti.com)

Mailing Address: Texas Instruments, Post Office Box 655303, Dallas, Texas 75265  
Copyright © 2011, Texas Instruments Incorporated